



+91-8048601626

Brilliant Engineering Works

<http://www.brilliantengineering.in/>

Brilliant Engineering Works is an ISO 9001:2008 certified manufacturer and supplier of Industrial Nozzles, Fire Fighting Equipments and Water Cooling Systems. The fire fighting equipment offered by us are known for fire resistance and robustness.

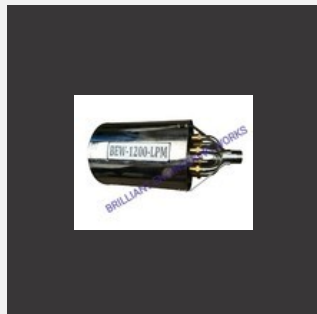

Profile

Established in the year **1995**, we, “**Brilliant Engineering Works**”, are a prestigious **ISO 9001:2008** certified business organization engaged in manufacturing and supplying a pristine assortment of **Industrial Nozzles, Fire Fighting Equipments and Water Cooling Systems**. Offered array of fire fighting equipment is manufactured using superior-grade raw material, which is sourced from the certified vendors of the market. Further, we employ modern machines, advent technology and sophisticated technologies during the fabrication process. Owing to this, the offered array is widely acknowledged by the clients for robustness, corrosion & fire resistance, longer service life, high strength and immunity against various chemicals. Relying on these attributes, our range is widely used in diverse industrial applications for varied purposes. We also provide **Repairing & Maintenance Services** to our clients. We have developed a sophisticated infrastructure at **Mumbai, Maharashtra, India**, where all the business activities are carried out in a streamlined manner. The infrastructure is well-equipped with all the necessary machines and equipment that are required for the precise & smooth execution of the business operations. Further, the entire machinery is frequently lubricated and updated to assure efficient functioning, thereby securing optimum output. Further, the machines and equipment are handled & operated by expert professionals to assure a safe & secure production period. Additionally, we have developed an in-house quality testing unit, where the entire range of finished stock is thoroughly tested on varied parameters to assure flawlessness and zero-defect. Owing to this, we have been able to earn the trust & confidence of some of the major reputed clients such as New Age Industries, Voltas Limited and Siemens India Private Limited.



WATER MONITORS AND NOZZLES



Remote Controlled Fire Water Monitor



Portable Water Monitor



Mobile Fire Fighting Monitor



Portable Ground Water Monitor

FOAM MAKING EQUIPMENT



Foam Purer 1200 LPM



Medium Expansion Foam Bund Purer 600 LPM



Medium Expansion Foam Bund Purer 1200 LPM



Foam Bund Purer 600 LPM

WATER SPRAY NOZZLES



Water Curtain Spray Nozzle



Bronze Sprinkler



Mist Nozzle



Bronze Medium Velocity Spray Nozzle

INLINE INDUCTORS



Foam Inductor



Inline Inductor

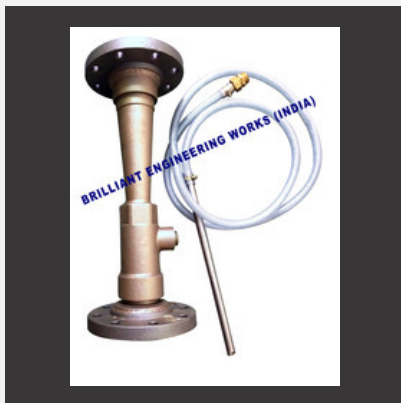

Foam Inductor



Inline Foam Inductor

FIRE HOSE REEL JET SPRAY NOZZLE



Jet Spray nozzle



Jet Spray Nozzle

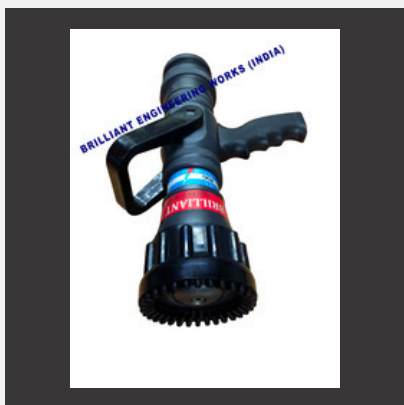

Selectable Gallonage Nozzle

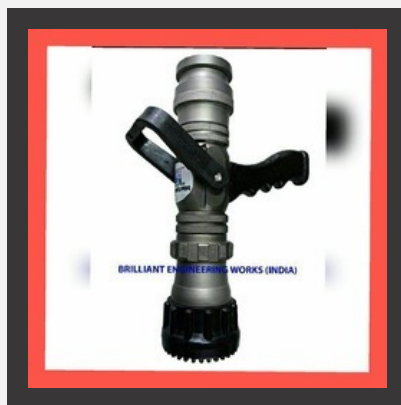

Fire Nozzle

BREACHING



Two Way Inlet Breaching



Three Way Inlet Breaching



Four Way Inlet Breaching

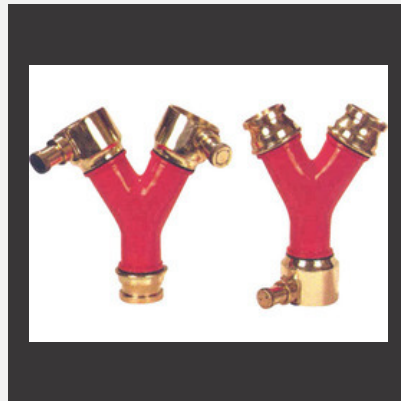

Dividing Breaching

HYDRANT VALVE AND LANDING VALVE



Oblique Hydrant Valve



Single Headed Hydrant Valve



Double Headed Hydrant Valves



Steel Double Headed Hydrant Valves

ADAPTORS AND COUPLING



Double Female Adapter



Double Male Adapter



Adapter With Female Lug

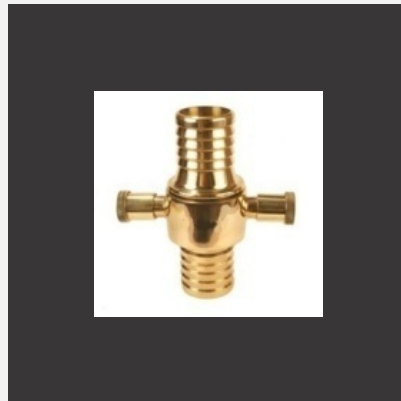

Fire Hose Delivery Coupling

SPRAY NOZZLES



Medium Velocity Spray Nozzle



Pendent Type Sprinkler



Spiral Nozzle for Cleaning



QC Nipples

FIRE PROTECTION SYSTEMS



Fire Extinguishers



Co2 Type Portable Fire Extinguishers



FRP Fire Hose Box



Co2 Fire Extinguishers

WATER COOLING SPARES



Mould Coupler



Quick Release Coupling



Mould Coupling

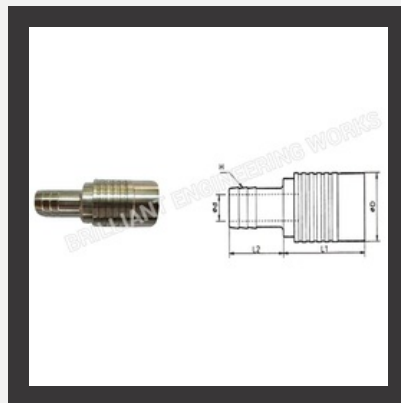

Mould Couplings

FIRE AND SAFETY



Mobile Wheel Chair



Mobile Chair



Mobile Wheel Chair

HYDRAULIC FITTINGS



Hydraulic Connector



Stainless Steel Nut



Ferrule Nut



Straight Adaptor

SWIVEL JOINTS



Swivel Elbow



Swivel Joints



Swivel Joints with Female Threads

NON RETURN VALVES



Non Return Valve Nozzle



63 MM Non Return Valves



Check Valve



NRV Check Valve

FIRE FIGHTING EQUIPMENT



Air Release Valve



Foam Tanks With Hose Reel



Hydrant Valve



Hose Rack

Factsheet

Year of Establishment : 1995

Nature of Business : Manufacturer, Exporter, Wholesaler, Trader

Total Number of Employees : 11 to 25 People



CONTACT US

Brilliant Engineering Works

Contact Person: H. V. Chauhan

Gala No. D- 6, Sai Kripa Society, Netaji Nagar, Hill No. 3, Opposite Sharma
Vidyalay, Sakinaka
Mumbai - 400072, Maharashtra, India



+91-8048601626



<http://www.brilliantengineering.in/>

